

道徳と紐結び

中研院台史所總督府圖書



3 0600 0 3282490 7



1921

8

24
99-9-8
99-9-8

此本ヲ御覽下サル 皆サマヘ

此本ニハ、縫取ト紐結トノ作例壹百有餘種ヲ集メテ「縫取ト紐結」ト題シマシタ。

私ハ、是ヲ小學校女生徒諸嬢ノ參考用ニ供シタイト思ヒマス。

儲テ、紐結ハ、内容ノ圖ヲ見テ、番號順ニ結びサヘスレバ、何方ニモ容易ニ拵ヘル事ガ出來マスカラ、別段説明ハ申上ゲマセン、只縫取ニ就テノミ、次ノ頁ニ簡單ニ述べテ置キマシタカラ、必ず是ヲ良ク讀ンデ後、縫取ナサイ。

縫取と紐結

縫取と紐結



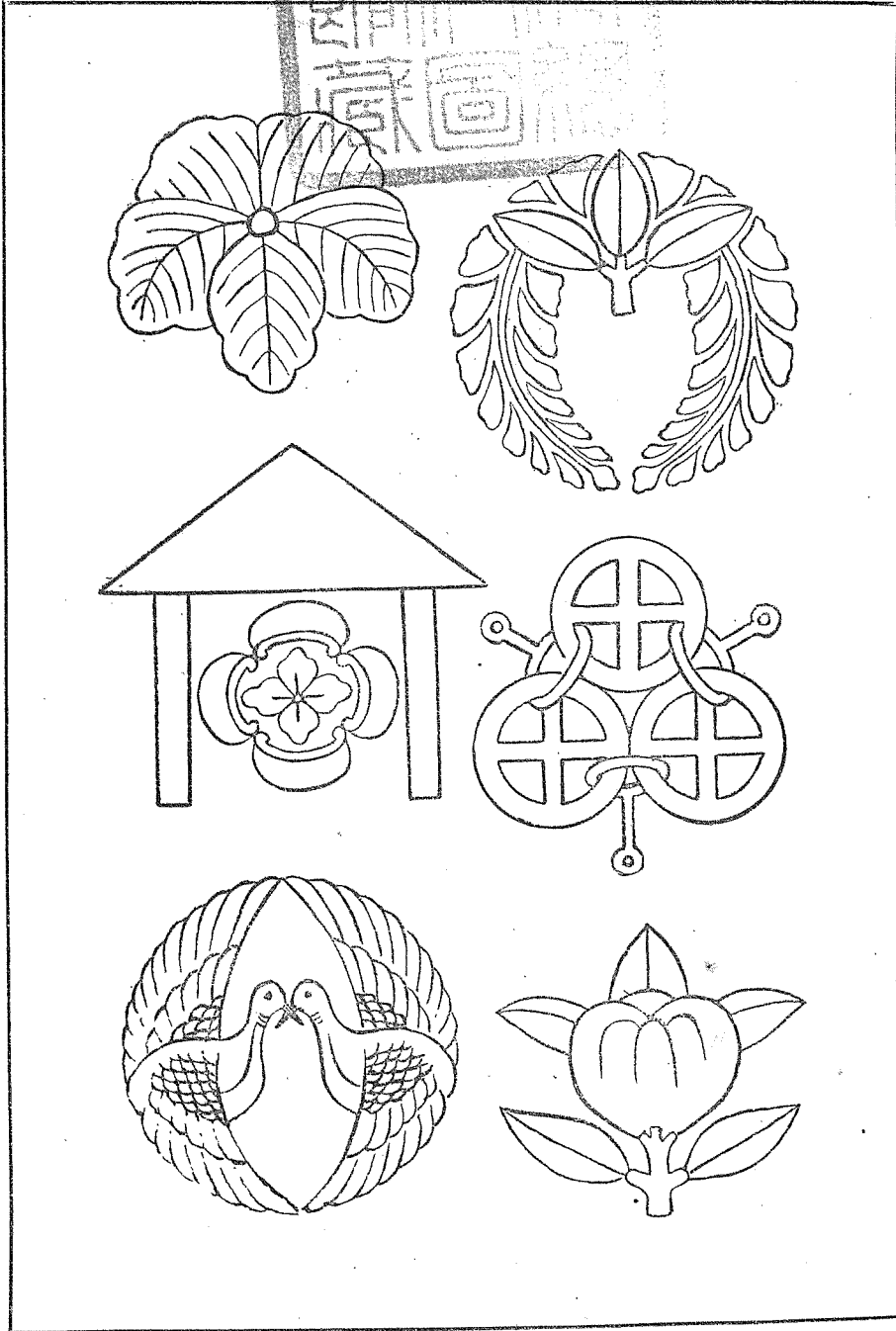

縫 方 の 一 斑

一、直線模様ニノミ用ヒラル。

二、直線デ表ハス短キ部分ニ用フ。

三、花粉等ノ如キ點デ表ハス部分ニ用フ。

四、太ク表ヌ線又ハ塗リツブシノ部分ニ用フ。

五、太ク表ハス線等ニ用フ。

六、太キ線又ハ塗リツブシノ部分ニ用フ。

七、曲線模様ノ線ニ用フ。

八、一種ノ飾縫ナリ。袴ノ腰板、ハンカチーフノ縁等ニ用フ。

九、是モト同ジク用ヒラル。

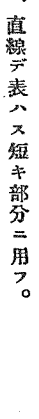
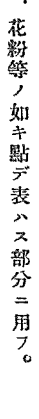
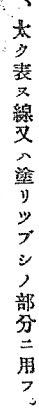
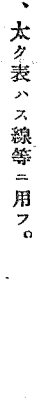
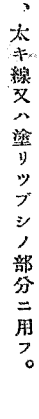
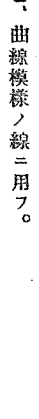
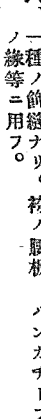
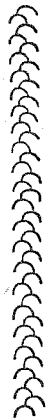

注意

○練習ニハ、縫取ラントスル形ヲ厚紙ニ下ガキ、エウツヨク、セツキンヌ、書シ、要所々々ニ接近シ過ギヌヤウ、針ヲキアテ先デ穴チアケテ置ク。

○糸ハナルベク實物ニ近キ色ヲ選ブ事。

○運針ノ幅ハナルベク小サクシ、皆等シク挿フヤウニスル事。

○糸ノ引キ加減ヲ均一ニスル事。

○仕上後ハ、裏ヨリ鑊ヲ當テ、形ヲ正ス事。

○用途ハ、コトモセマモリツケヒ用カザリ、チーフノ印、エプロンノ飾、風呂敷ノ印等、其他數ヘ切レヌ程アリマス。

○内容ニハ、紋形模様繪齋等ノ作圖七ノ有餘種、掲ゲテアリマスカラ、是等ヲ手本トシ、又參考トシテ、上圖九種ノ中適當ナ縫方チ選ンデ、縫取ナサイ。

○文字ノ縫取モ亦同様ニシテ、拵ヘル事ガ出来マス。

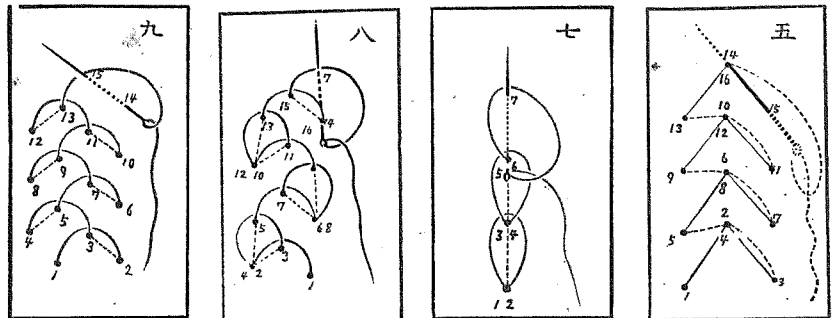

機結ビ

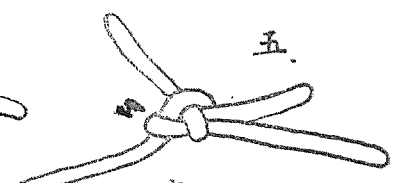
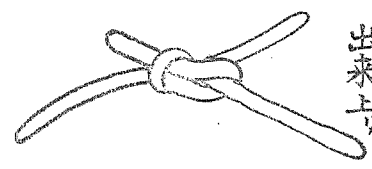
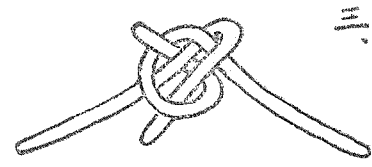
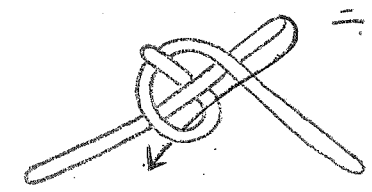
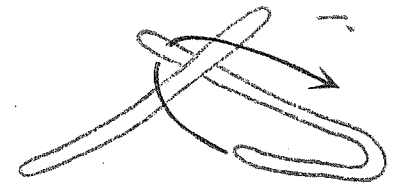

一

二

三

四

五

出来上リ

裏ノ四

五行結ビ

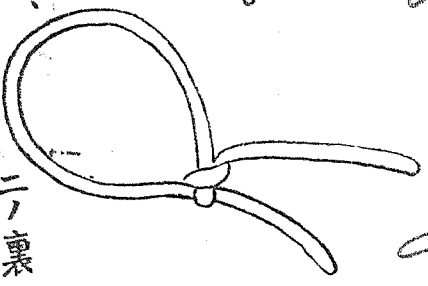
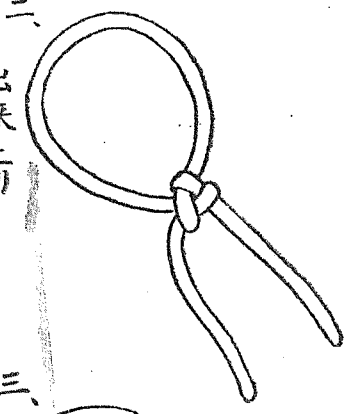
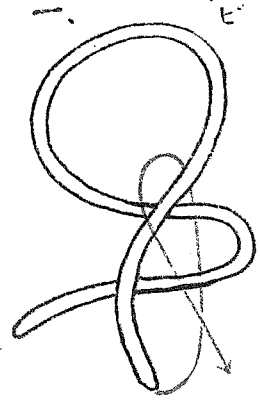

出来上リ

三

二ノ裏

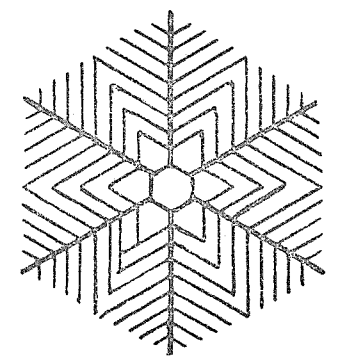
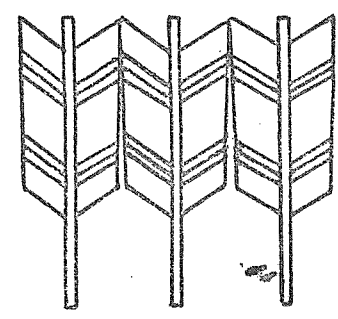
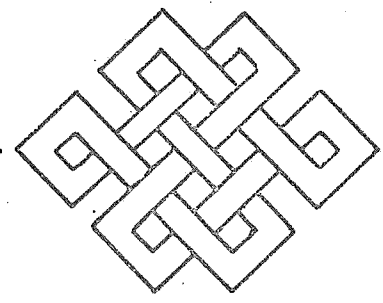
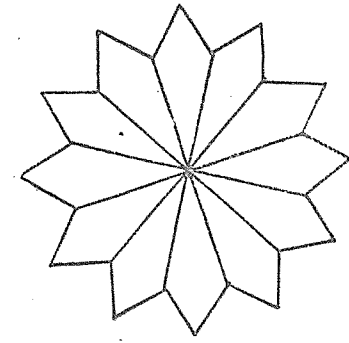
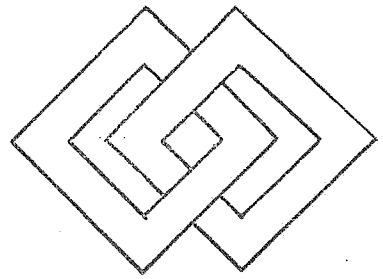
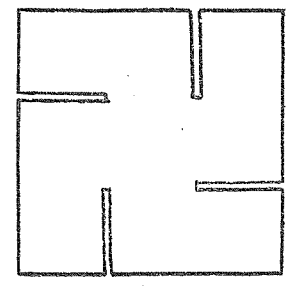

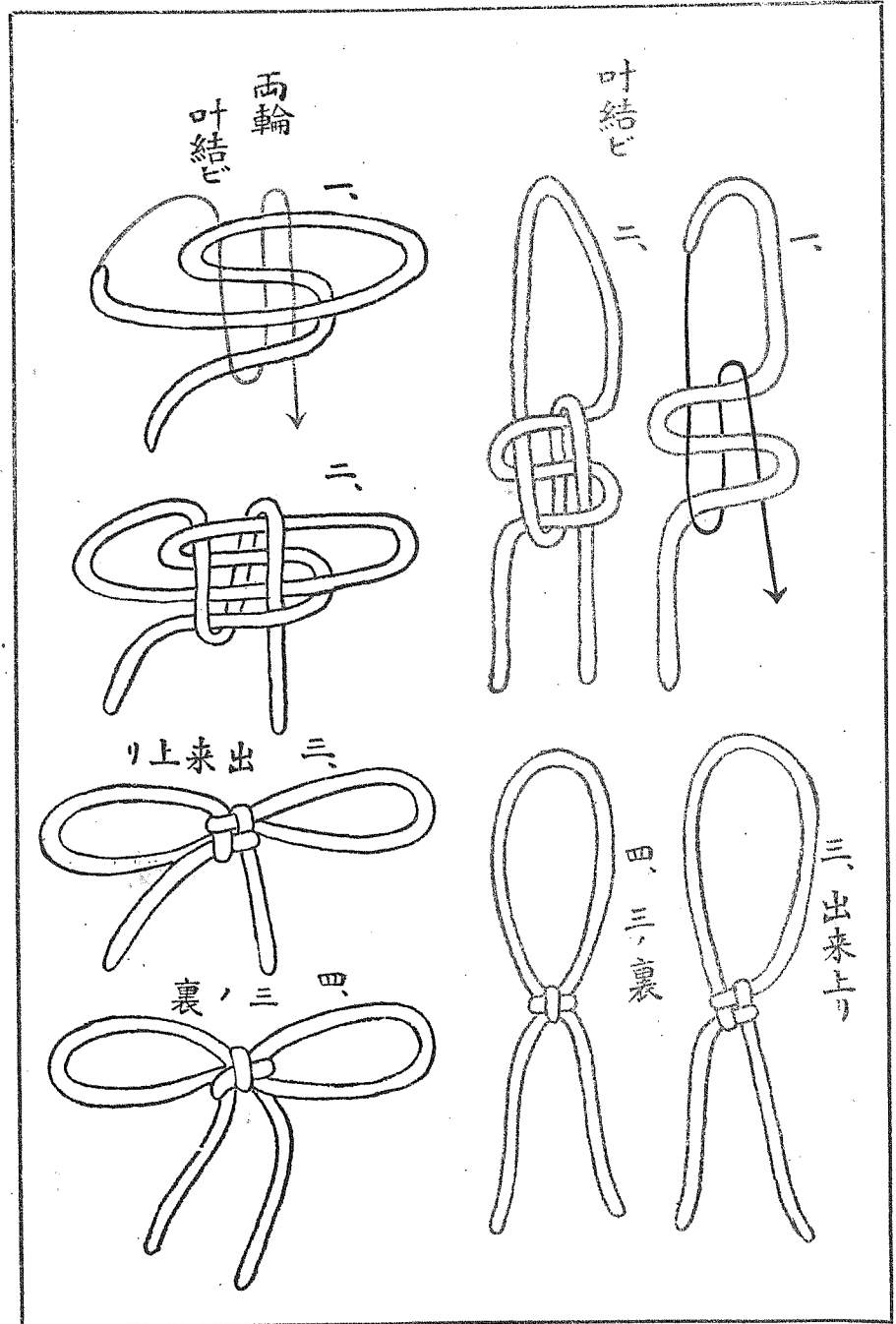
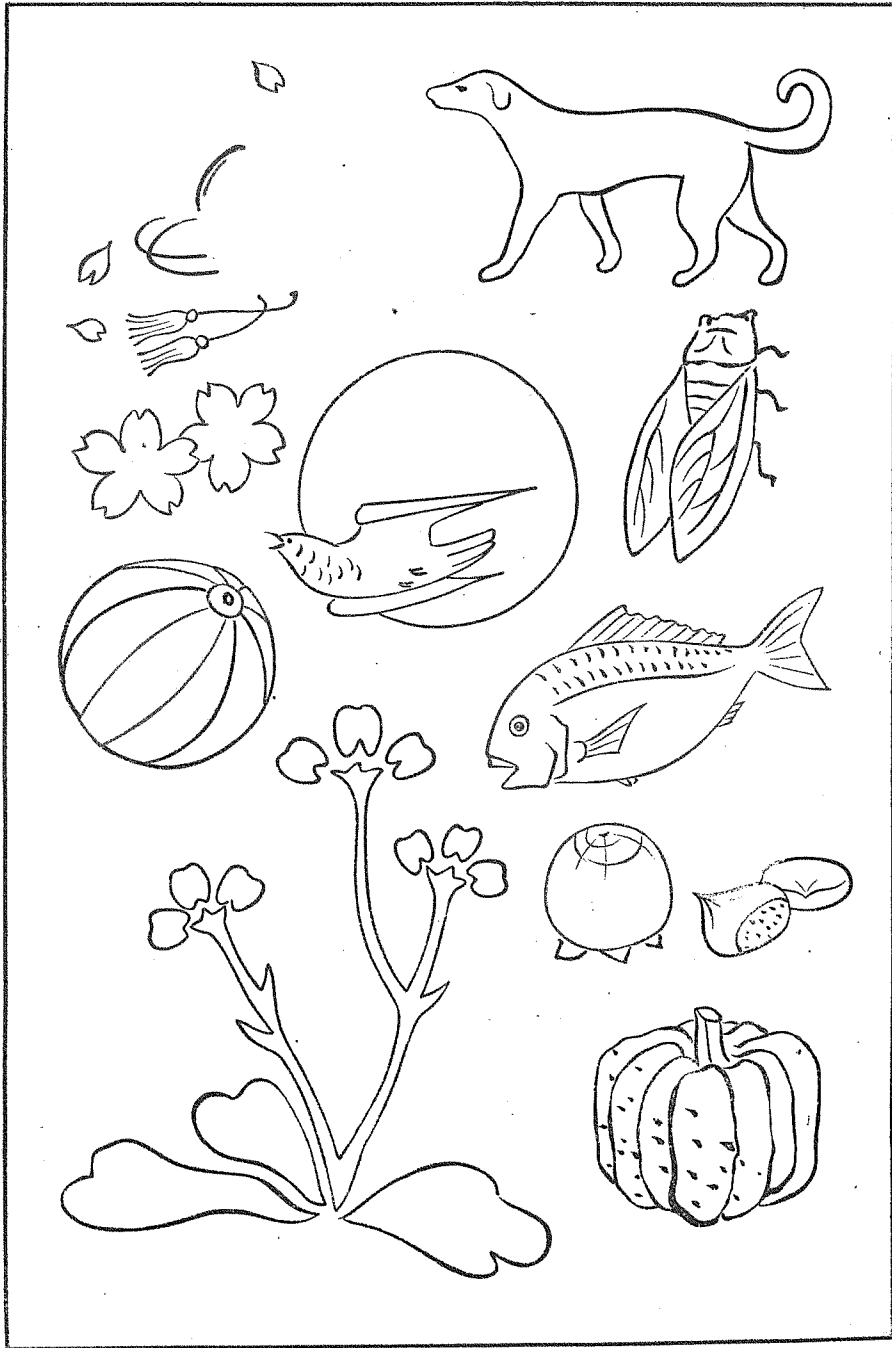

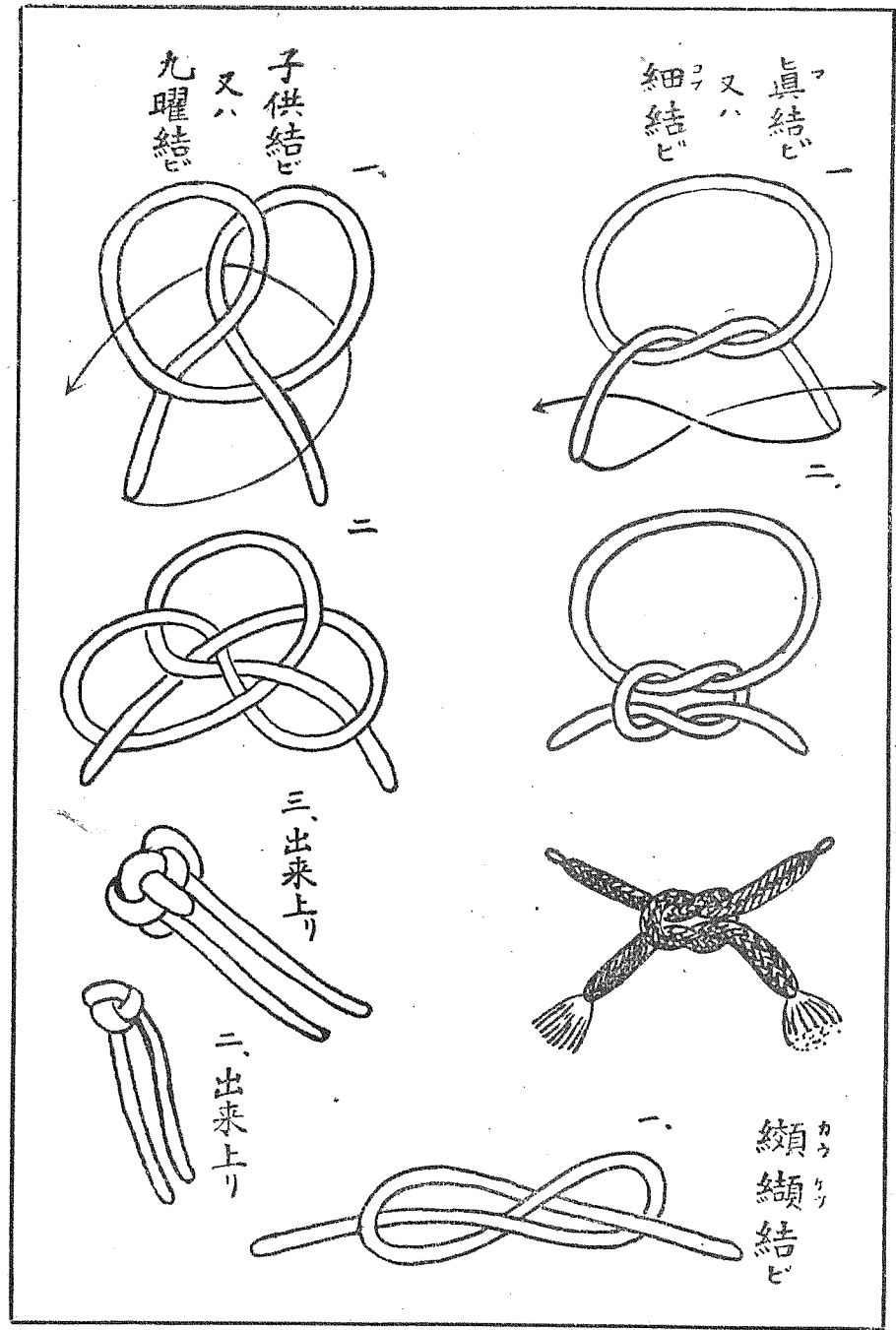
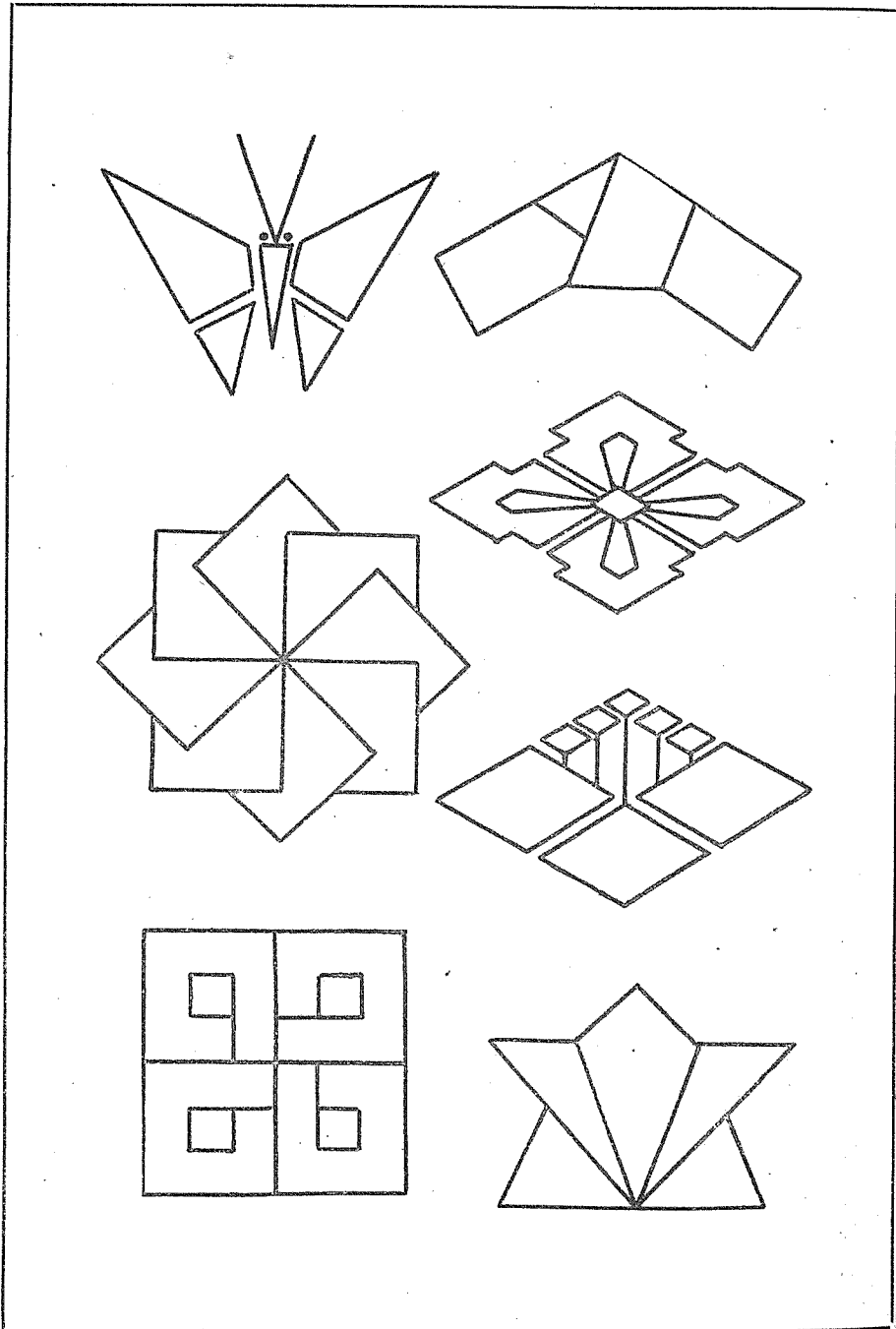

梅花結

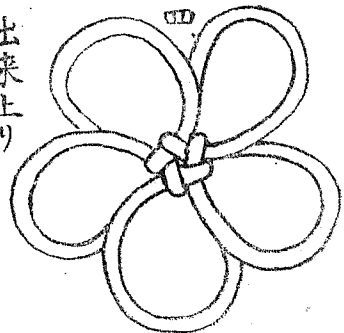
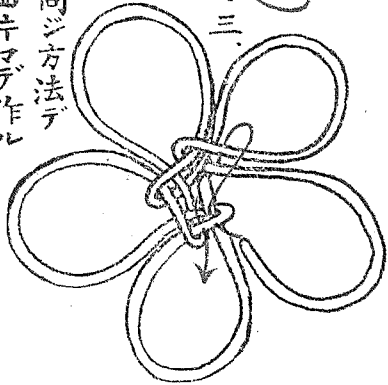
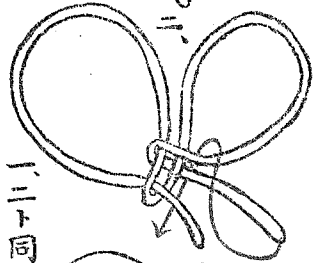
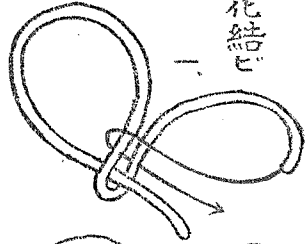

一、二、三、四、同シ方法デ
花辨ヲ四片マデ作ル

出来上リ

巾着結

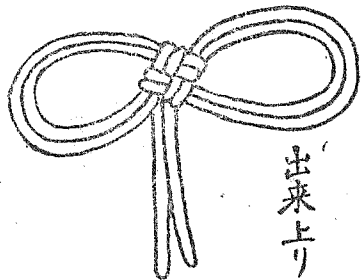
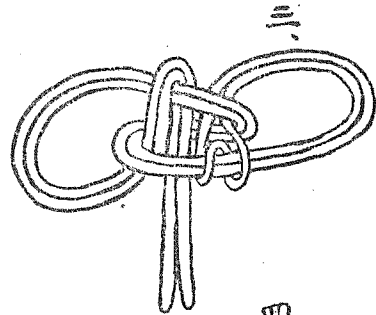
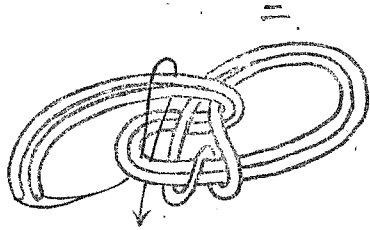
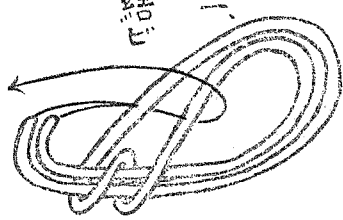

出来上リ

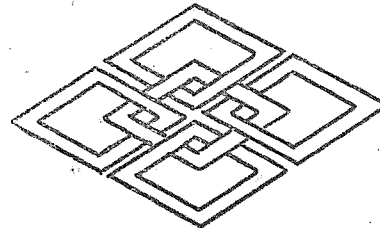
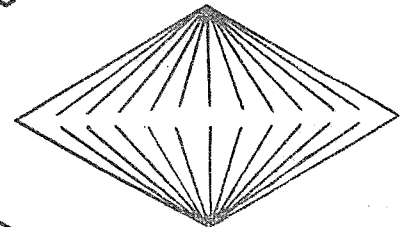
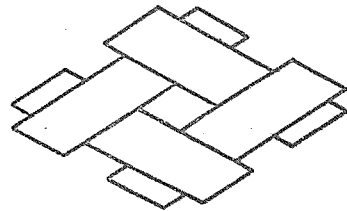
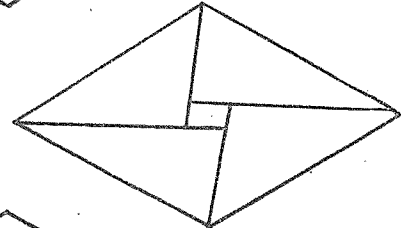
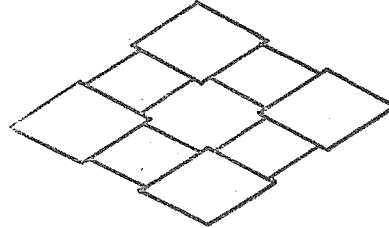
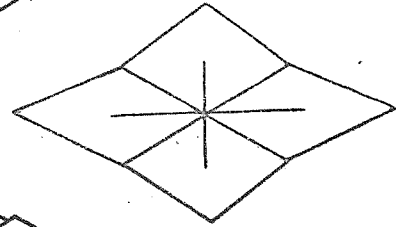
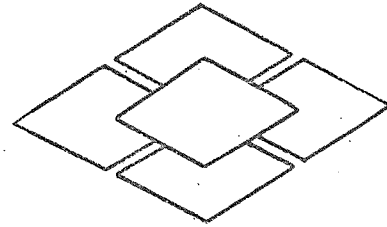

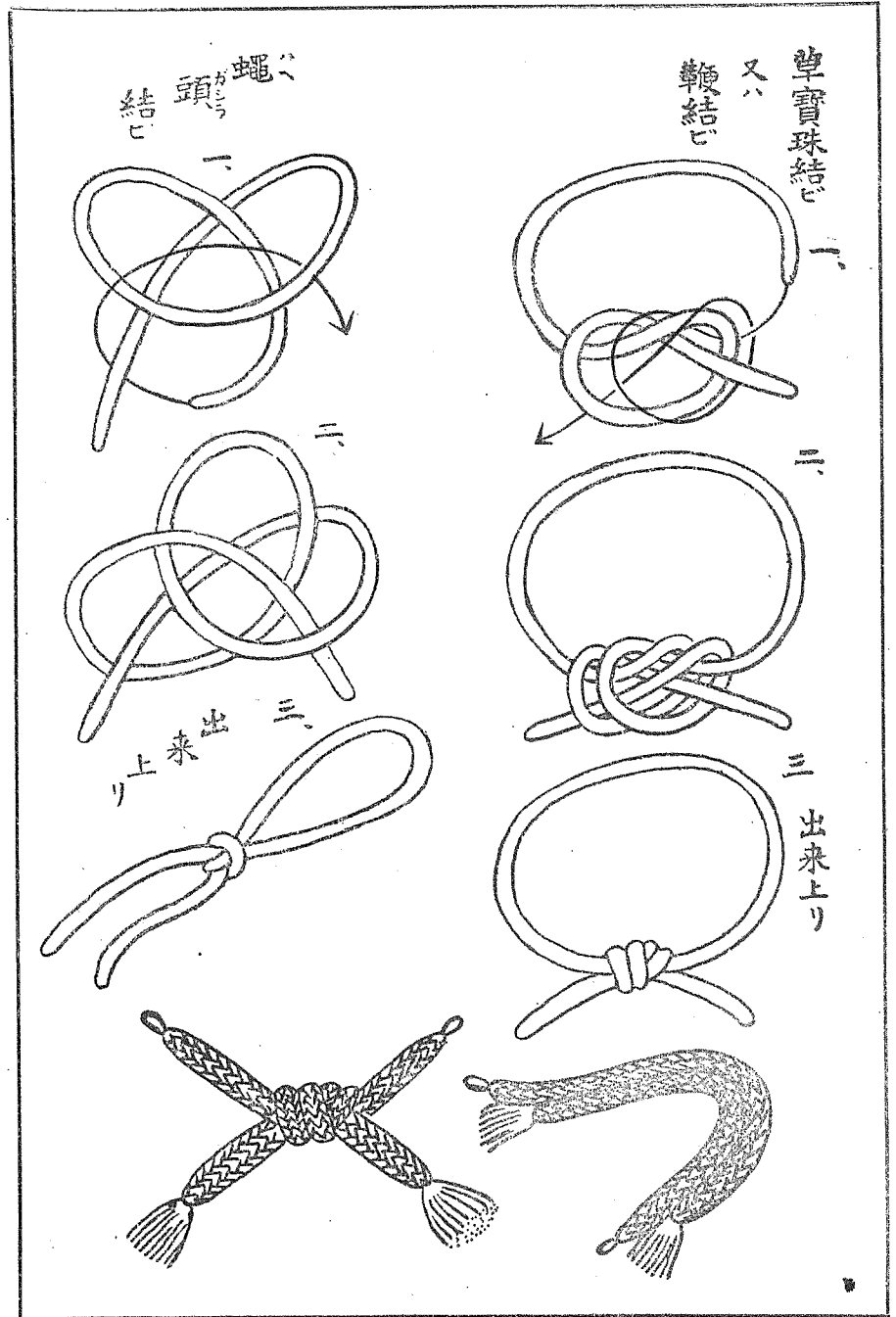
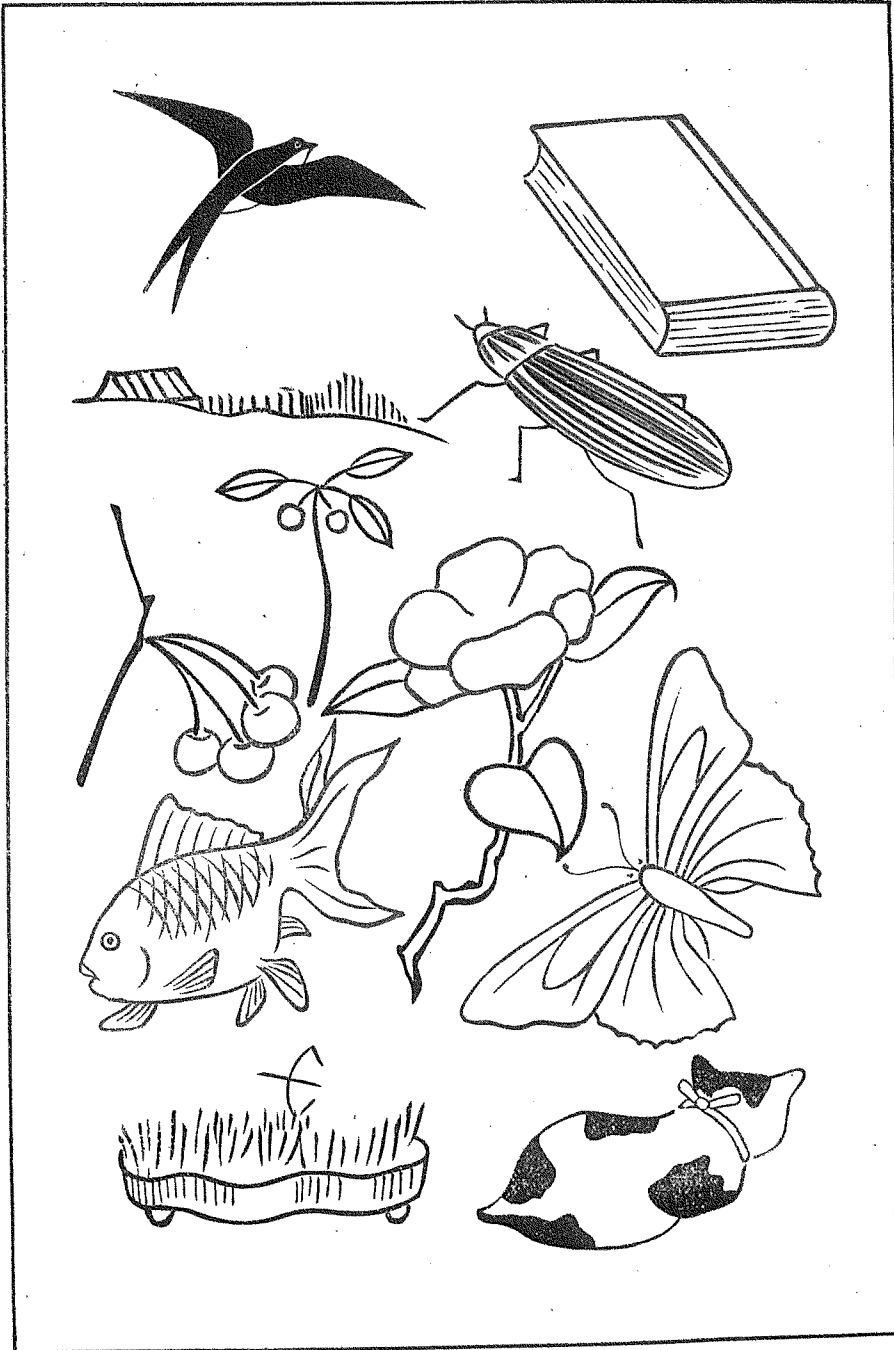

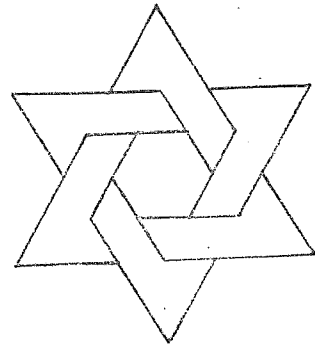
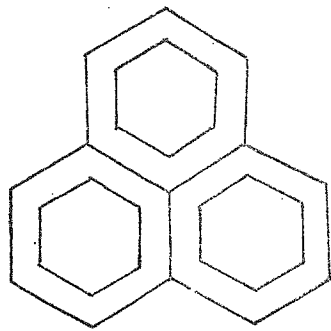
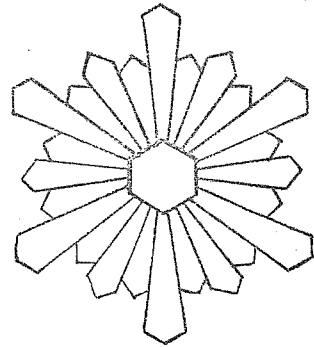
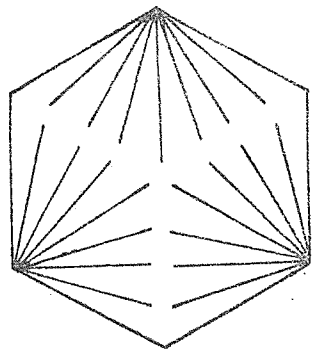
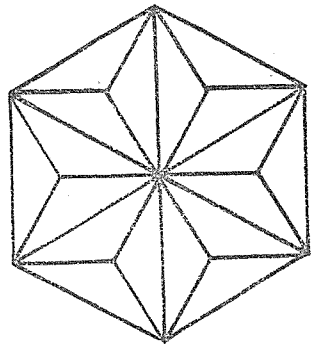
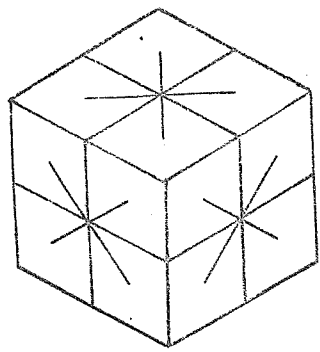

華蔓結

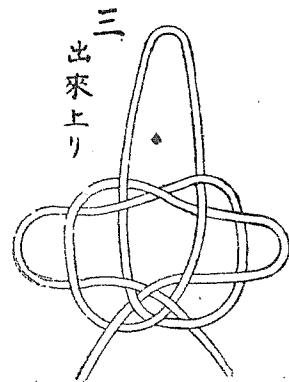
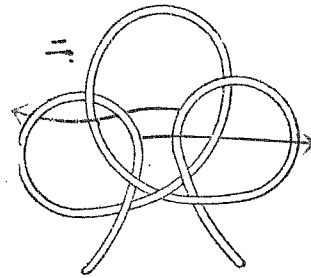
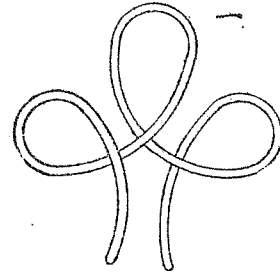

三 出来上リ

新帯結

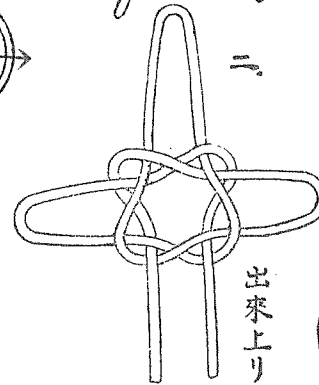
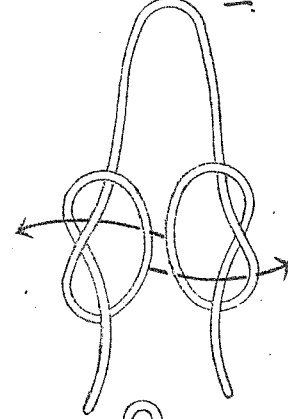

出来上リ

新帯結

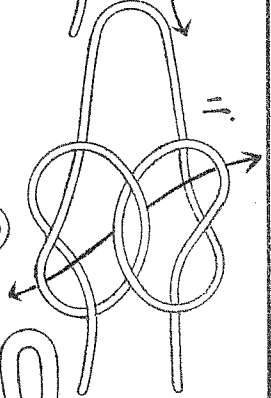
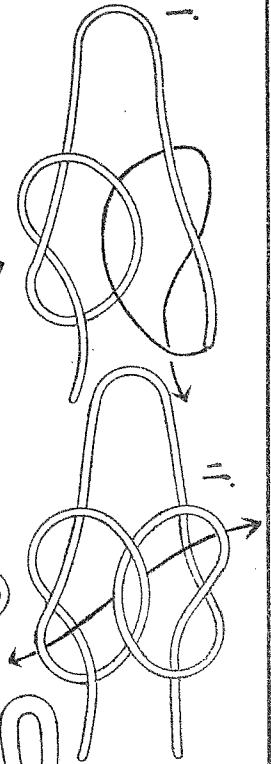

三

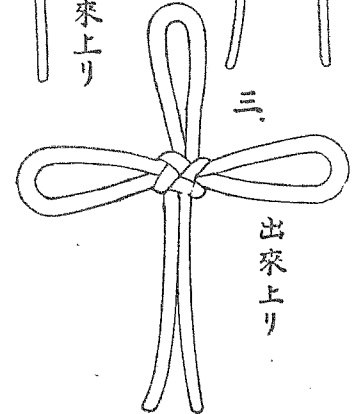

出来上リ

東結

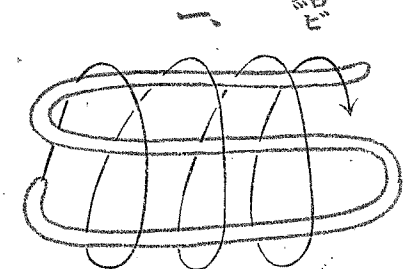

二

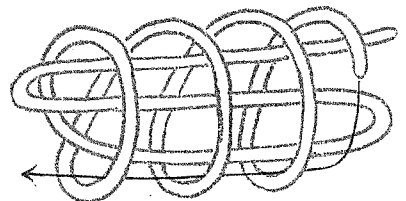

三

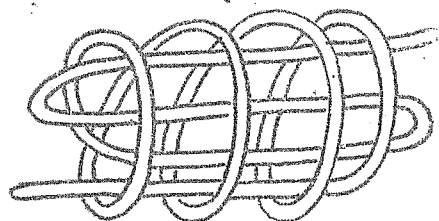

四

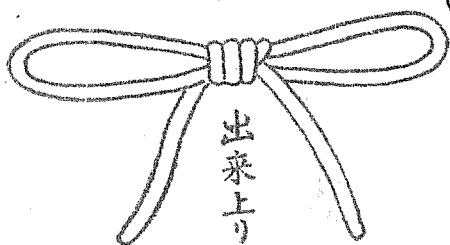

出来上リ

新橋結
楓結

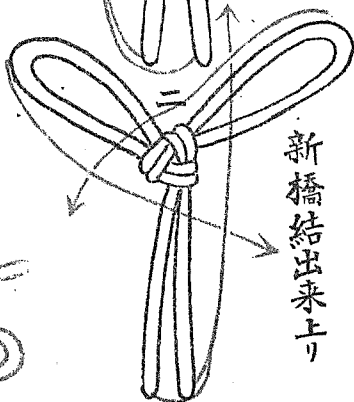
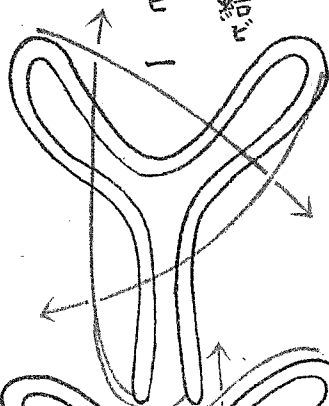

新橋結出来上リ

三

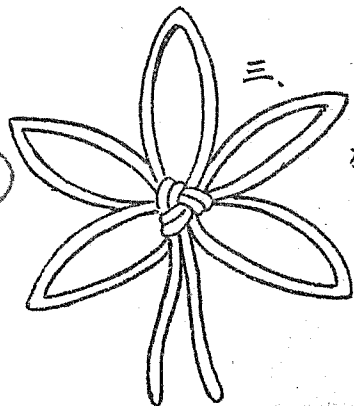

楓出来上リ

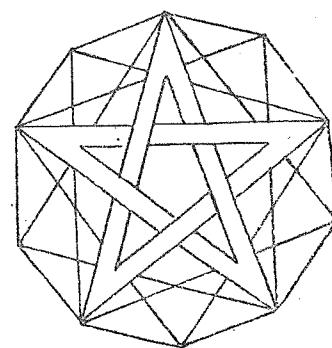
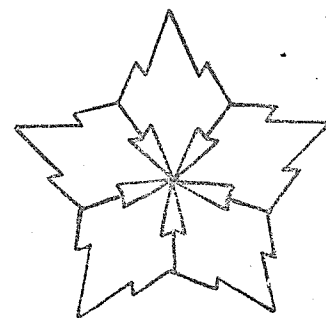
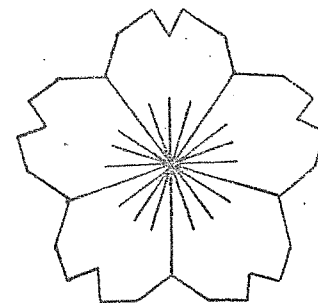
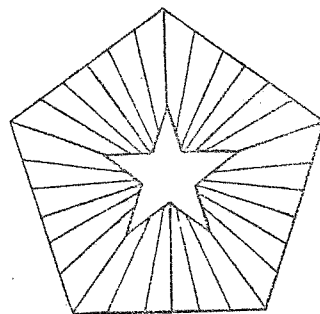
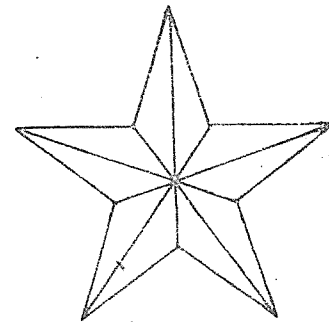
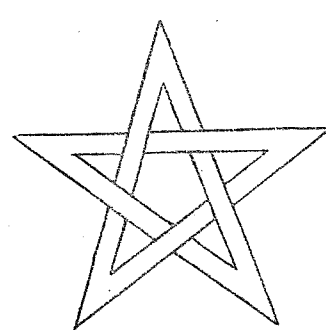

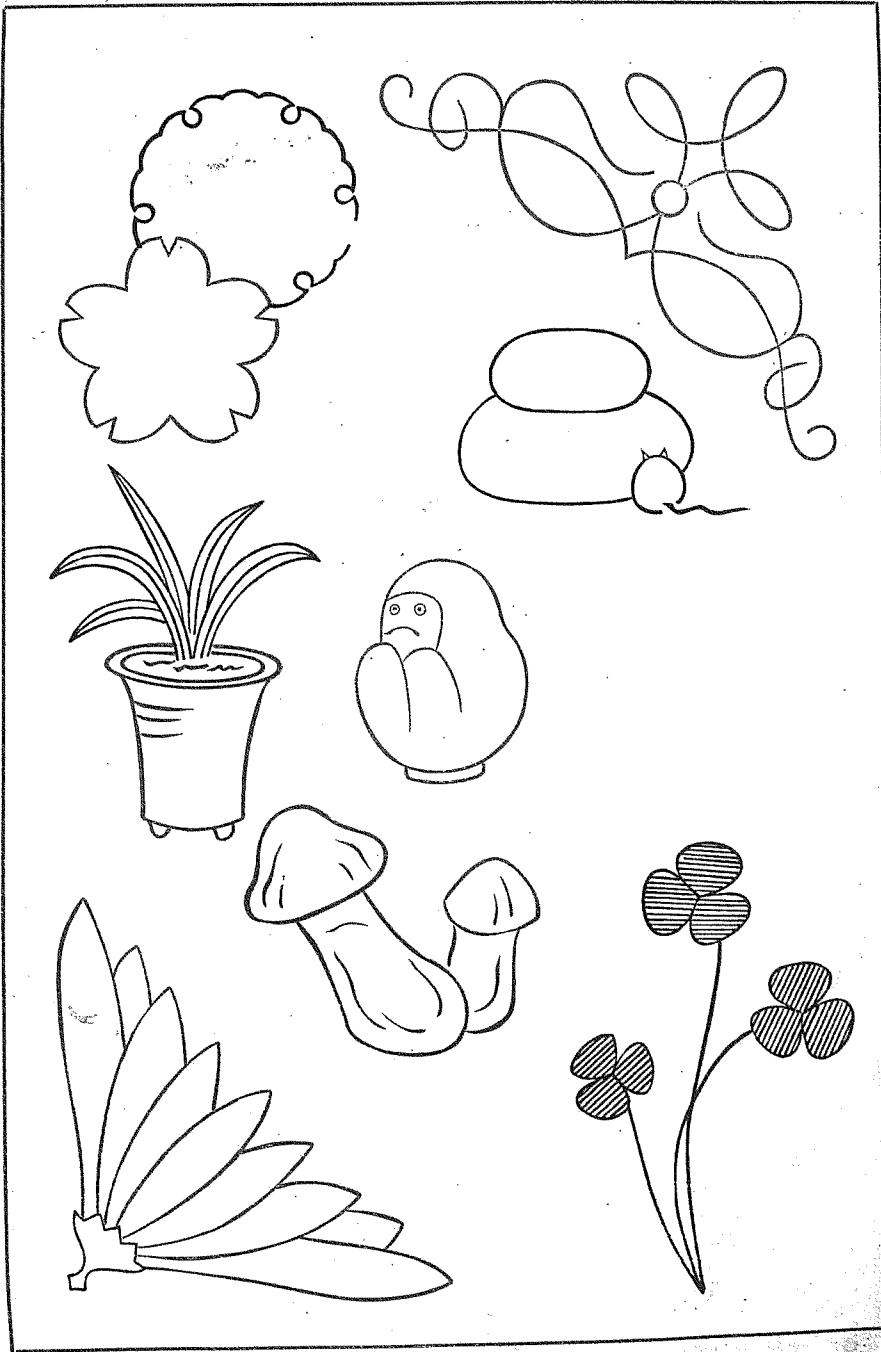

ビ結珠寶、眞

ヒ結蛉蜻、草

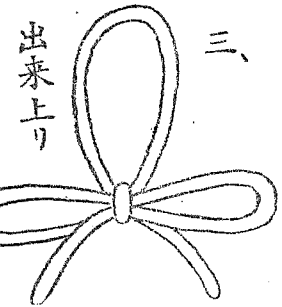
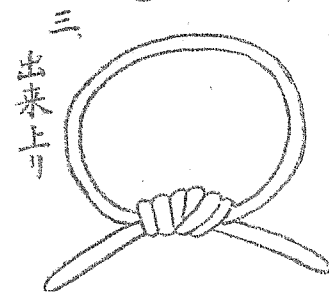
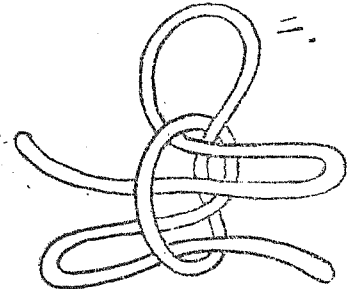
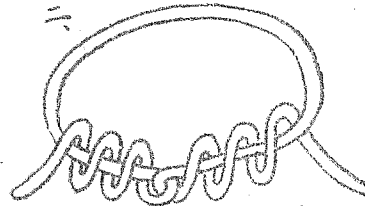
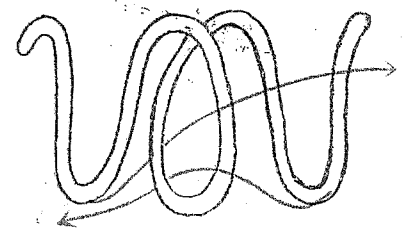
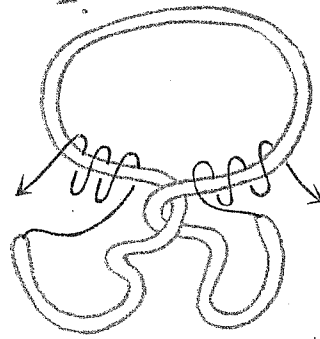

出来上リ

出来上リ

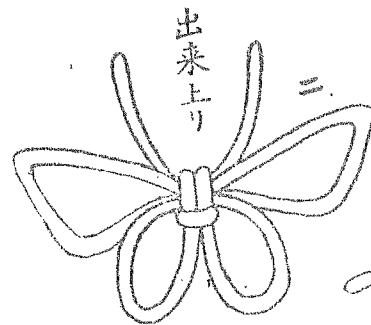

出来上リ

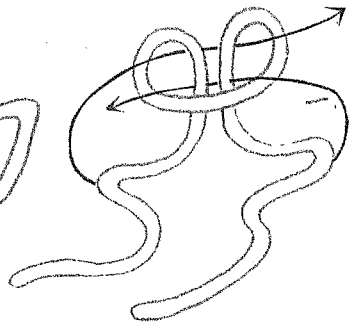

蝶結ヒ

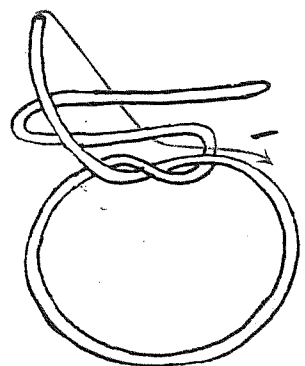
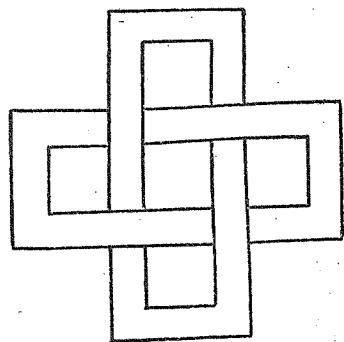
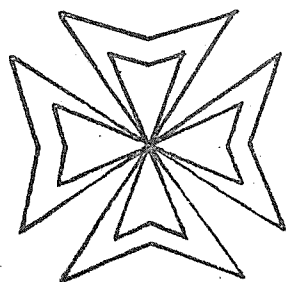
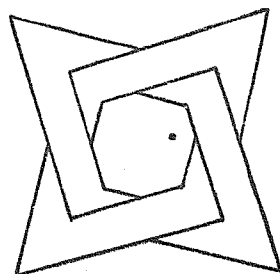
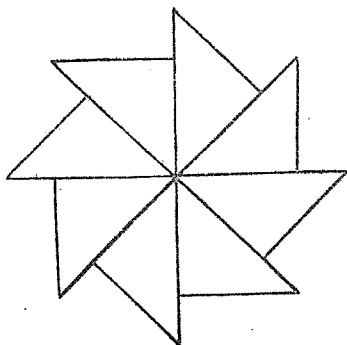
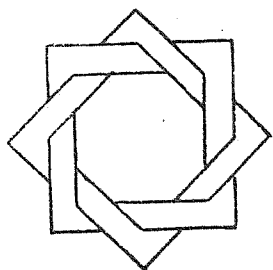
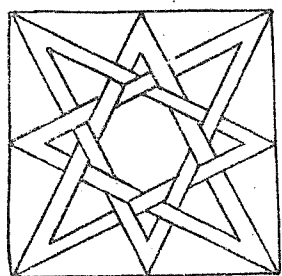

片膝折結ビ

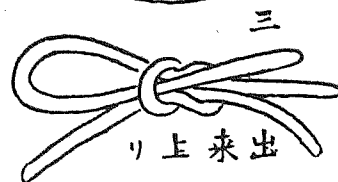
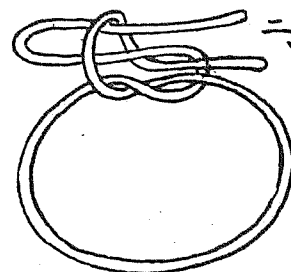

リ上来出

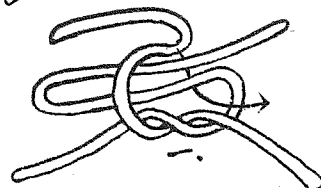

両膝折結ビ

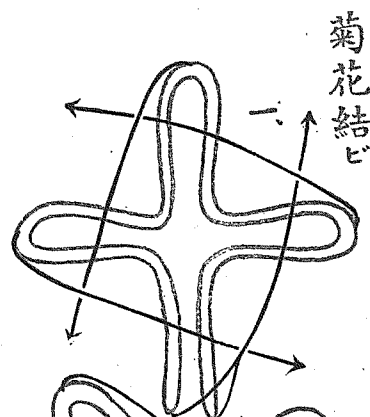
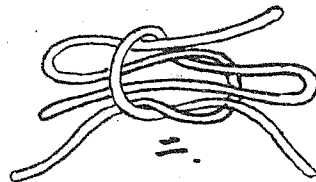

菊花結ビ

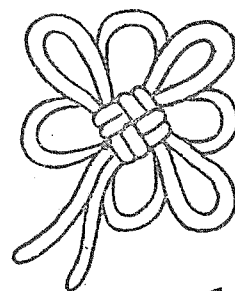
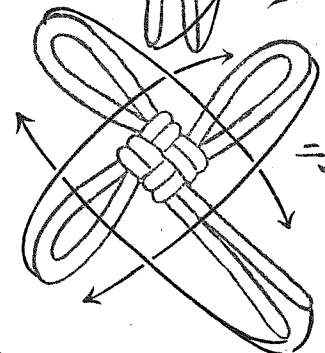

三出来上リ

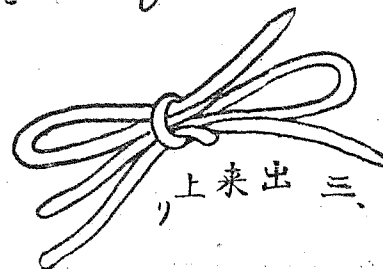

リ上来出 三

鳥頭結

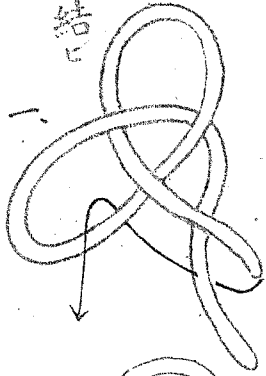

二

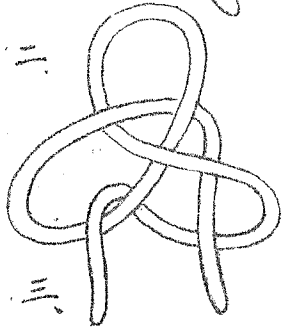

三

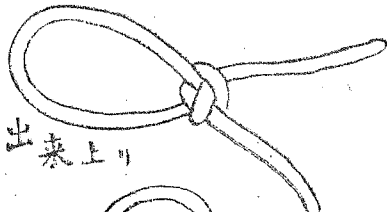

出来上リ

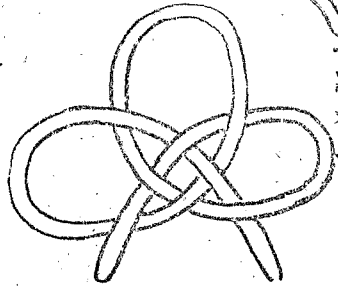

二出来上リ

四手結

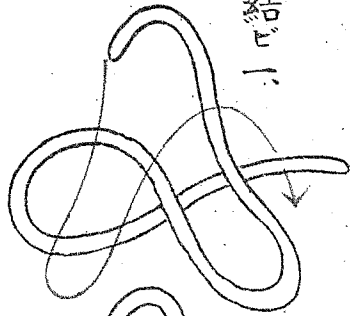

二

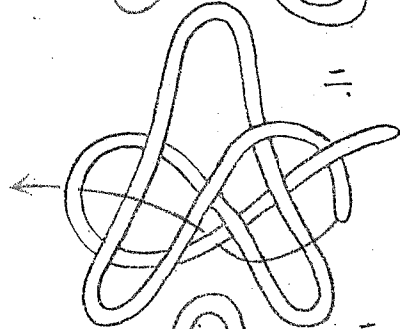

三

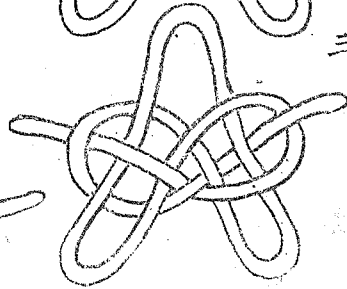

出来上リ

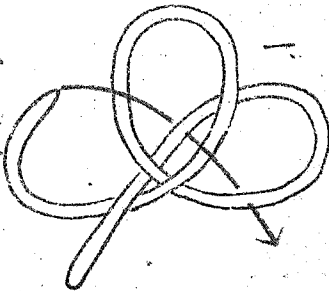

淡路結

蜻蛉頭結
ガシラ

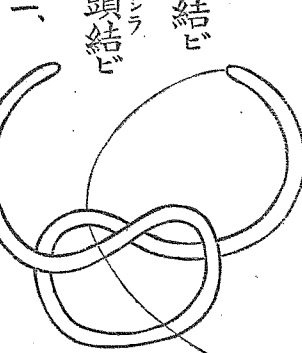

二

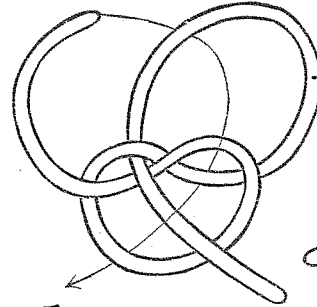

三、胡蝶出来上リ

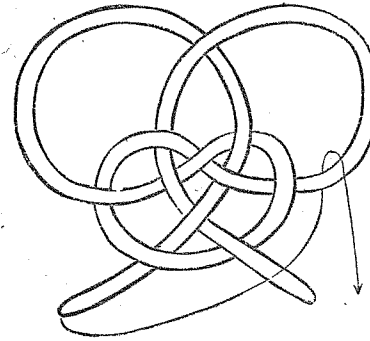

四蜻蛉頭出来上リ

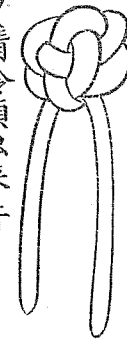

玉結

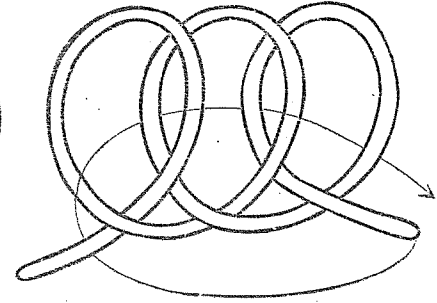

二

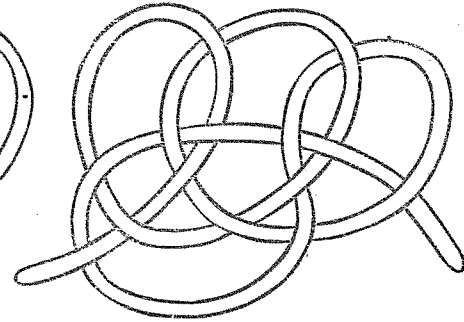

三

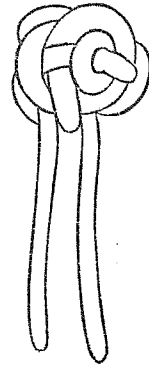

出来上リ

家庭参考小學手工書

全十三册
完 成

東京
電話

册拾八錢紙幣三錢〇六册郵稅共九拾五錢〇十二
册紙幣共三圓八拾錢

1	カミキリ又キ雪花	7	縫取と紐結
2	手エノイロイタ	8	竹サイクムキワラ
3	カミキリ又キ月	9	ハリリケサイク
4	カミキリモノ	10	サイケモノ
5	カミキリ又キ雪	11	キリ又キ細工
6	アツカミ細工	12	ヲリカミ細工

鈴木江南 全文四 活字綴ワリカキ付

解題 キリ又キ十二月

口給賞物券黄色 十冊
挿圖百四十餘 定價金拾五錢 郵稅四錢
マア美シイ、マア不思議、切抜細工の面白サ、花ヤ、オ
ト例テモ出来ル、ゴマカク説イテ誰ニモワカル、此本一
冊未だ三、四、五、六、七、八、九、十、十一、十二、月ノ好テ物ヲ

國定小學書キ方手本筆者 板倉折枝先生
森田太三郎先生

新案 お伽習字書帖

全六册各册石版
數度刷手本六枚
紙幣十八枚
定價拾貳錢

カタカナ 上下三册 (上、出来) (下、近刊)
平かな 上下三册 (上、出来) (下、近刊)
本字交り 上下三册 (上、近刊) (下、近刊)
新案お伽習字書帖は、筆者、板倉折枝先生、宇も巧
山まつて又と見られたる、其間に面白サ、話や、ウチヤ、オシヤの
の先生、給書は森田先生、親切な家庭教師であります。

大正四年八月十八日印 刷
大正四年八月廿三日發行 (縫取と紐結)
大正五年四月十日 再版發行

附 與 著 者 所 有 權
定價金拾八錢

發賣所

東京市芝區 田村町七番地 振替東京(七五六八番)
上村龍之助
鈴木江南
増田秀吉
發行所 振替東京(七五六八番)
印刷者 田村町七番地

謹告
本書は、多年ノ經驗ト實地トニヨリ新案ヲシテ、
チモ併セテ記載仕候ニ付御不審、點モ候ハ、御照會(返信
料添)ヲ得、即時御回答仕候
東京市芝區田村町七番地長久社内 著者 鈴木江南